

DESIGNED  
& PRODUCED  
IN THE UK.

#SetTheBenchmark



BENCHMARK

A style to suit every home.

AVAILABLE IN  
A FULL RANGE  
OF COLOUR  
& HARDWARE  
STYLES.

WHERE  
ENERGY EFFICIENCY  
MEETS SECURITY.

[solarcalibrenorvik.com](http://solarcalibrenorvik.com)



**SOLAR  
CALIBRE DOORS**

A part of the **Solar Group.**

# CONTENTS

<b>1. Introducing Benchmark</b> .....	p3
<b>2. Product Range Overview</b> .....	p4
<b>3. Colour Options</b> .....	p6
<b>4. Quality Construction</b> .....	p8
<b>5. Our Traditional Doors</b> .....	p10
<i>The Moorgreen</i> .....	p12
<i>The Butterley</i> .....	p12
<i>The Kingston</i> .....	p12
<i>The Sherford</i> .....	p14
<i>The Derwent</i> .....	p16
<i>The Amber</i> .....	p18
<i>The Sandhill</i> .....	p20
<i>The Dove</i> .....	p20
<i>The Ecclesbourne</i> .....	p22
<i>The Lathkill</i> .....	p24
<i>The Eden</i> .....	p26
<i>The Beeston</i> .....	p28
<i>The Erewash</i> .....	p30
<i>The Ogston</i> .....	p31
<i>The Trent</i> .....	p32
<i>The Speedwell</i> .....	p34
<i>The Wye</i> .....	p36
<i>The Avon</i> .....	p36
<b>6. Our Contemporary Doors</b> .....	p38
<i>The Shardlow</i> .....	p40
<i>The Tyne</i> .....	p40
<i>The Milton</i> .....	p42
<i>The Farndon</i> .....	p42
<i>The Hilton</i> .....	p44
<i>The Loxley</i> .....	p46
<i>The Calder</i> .....	p46
<i>The Sheaf</i> .....	p48
<i>The Arun</i> .....	p48
<i>The Neath</i> .....	p48
<i>The Repton</i> .....	p50
<i>The Thames</i> .....	p52
<i>The Colwyn</i> .....	p52
<i>The Ogmores</i> .....	p52
<b>7. The Benchmark Guarantee</b> .....	p56
<b>8. Toplights, Sidelights</b> <b>&amp; Panel Options</b> .....	p58
<b>9. PVC-U Toplight &amp; Sidelight</b> .....	p59
<b>10. Hardware Options</b> .....	p60
<b>11. Hardware Upgrades</b> .....	p64
<b>12. Glazing Options</b> .....	p68
<b>13. Frame, Sill &amp; Threshold Options</b> ..	p70
<b>14. Customer Support</b> .....	p72
<b>15. Discover More From</b> <b>Solar Calibre Doors</b> .....	p73



# INTRODUCING BENCHMARK

The first impression of your home is your front door. With a Benchmark door you not only add instant kerb appeal to your property but you can enjoy all the added benefits that a modern composite door brings.



Using only the best quality components, Benchmark doors are designed and manufactured without compromise.

With a range of styles, from country cottage and Edwardian townhouse to more contemporary offerings, you can be sure to find the perfect door for your home.



## Energy efficiency

Save money and the planet with a Benchmark door.

Energy efficiency is important to all of us. We all want to be more energy efficient, to reduce our fuel bills and to protect the future of our planet. A Benchmark composite door is the perfect way to improve the energy efficiency of your home.

As standard, our doors without glazing panels enjoy an A++ rating while our glazed doors still carry an impressive A+ rating. You will also see a U-value rating on all our doors which is a technical measurement of heat loss through a structural element. The lower the U-value the better the energy efficiency.



## PRODUCT RANGE OVERVIEW

If you are looking for style, choice and thermal efficiency then our composite doors are the perfect choice. With a range of colours and finishes to choose from, a Benchmark door will help your home make the right first impression.

### Traditional Doors



Moorgreen  
**p12**



Butterley  
**p12**



Kingston  
**p12**



Sherford  
**p14**



Derwent  
**p16**



Amber  
**p18**



Dove  
**p20**



Sandhill  
**p20**



Ecclesbourne  
**p22**



Lathkill  
**p24**



Eden  
**p26**



Beeston  
**p28**



Erewash  
**p30**



Ogston  
**p31**



Trent  
**p32**



Speedwell  
**p34**



Wye  
**p36**



Avon  
**p36**

## Contemporary Doors



Shardlow  
**p40**



Tyne  
**p40**



Milton  
**p42**



Farndon  
**p42**



Hilton  
**p44**



Loxley  
**p46**



Calder  
**p46**



Sheaf  
**p48**



Arun  
**p48**



Neath  
**p48**



Repton  
**p50**



Thames  
**p52**



Colwyn  
**p52**



Ogmore  
**p52**

## COLOUR OPTIONS

We understand colour is very much a personal choice, which is why we offer a wide range of standard and premium colours to suit your home, from cool and conservative to something a bit more impactful. The choice is all yours.



### Standard Colours

1. White
2. Anthracite Grey
3. Green
4. Red
5. Black
6. Blue
7. Chartwell Green
8. Golden Oak
9. Rosewood



## Premium Colours



- |                              |                    |                |
|------------------------------|--------------------|----------------|
| 1. Agate Grey                | 13. Azure          | 26. Mushroom   |
| 2. Light Grey                | 14. Twilight       | 27. Putty      |
| 3. Silver Grey               | 15. Victory Blue   | 28. Irish Oak  |
| 4. Traffic Grey              | 16. Stormy Seas    | 29. Dusky Pink |
| 5. Shadow                    | 17. Caribbean Blue | 30. Pale Pink  |
| 6. Military Grey             | 18. Sage           | 31. Marsala    |
| 7. Basalt Grey               | 19. Olive Grove    | 32. Diablo     |
| 8. Slate                     | 20. Paradise Green | 33. Mulberry   |
| 9. Black Ash / Beck<br>Brown | 21. Emerald        | 34. Very Berry |
| 10. Moonshine                | 22. Citrine        |                |
| 11. Cotswold                 | 23. Clotted Cream  |                |
| 12. Nimbus                   | 24. Clay           |                |
|                              | 25. Sandstone      |                |

## QUALITY CONSTRUCTION

Our composite GRP door is all about providing maximum kerb appeal with minimal maintenance requirements.

The construction of our door surpasses other alternatives, incorporating an LVL (Laminated Veneer Lumber) subframe to provide the strength and rigidity required for modern homes. The door protects the home from the elements, but will have minimal thermal expansion and contraction rates under extreme temperature variations which is perfectly normal. The PU foam core meanwhile reduces heat loss, providing a high level of thermal performance.







8  
Poppyfield  
Road



1

---

# OUR TRADITIONAL DOORS

Whether it's a Victorian home, a modern townhouse or a farmhouse cottage, our traditional range of doors with highly defined mouldings and realistic wood-grain surface embossing make a real statement.



THE **MOORGREEN | BUTTERLEY | KINGSTON** SG15 | SG16 | SGE5



MAKE A STATEMENT WITH THE CLASSIC DUAL GLAZED DOOR

Choose from our wide range of decorative glazing options to add an additional personal touch.

- 1. The Moorgreen in Slate with Prairie glazing style
- 2. The Butterley in Diablo with Classic glazing style
- 3. The Kingston in Cream White with Elegance glazing style



Dimensions

Width			
Min (Narrow)	Min (Std)	Max (Narrow)	Max (Std)
804mm	840mm	984mm	1020mm
Height			
Min (Narrow)	Min (Std)	Max (Narrow)	Max (Std)
1962mm	1980mm	2070mm	2088mm

# Glazing Options

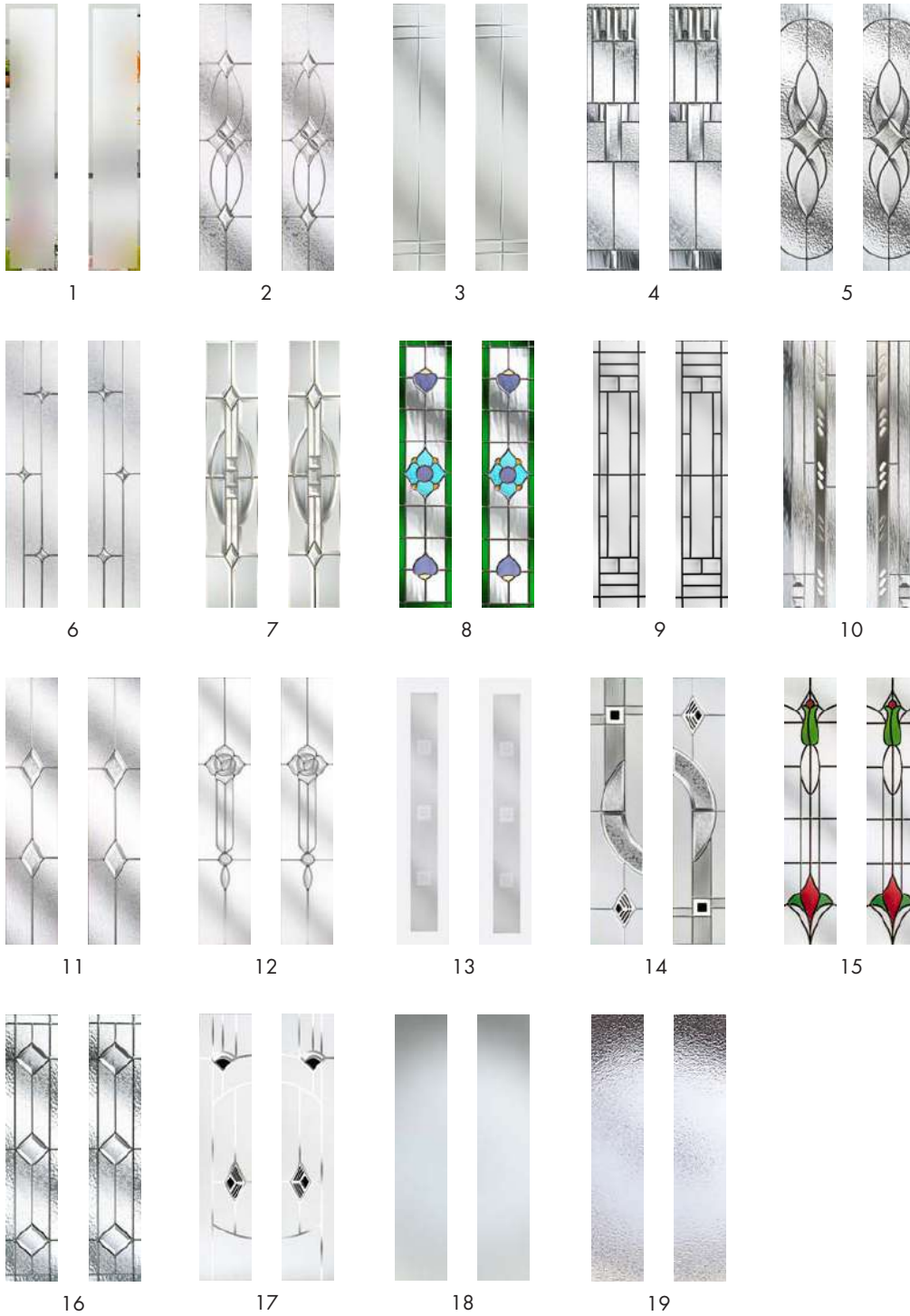

1. Kensington
2. Flair
3. Linear
4. Prairie
5. Elegance
6. Zinc Art Star
7. Reflections
8. Dorchester
9. New Orleans
10. Matrix
11. Classic
12. Crystal Flowers
13. Greenwich
14. Modena
15. Beaumont
16. Simplicity
17. Murano
18. Satin
19. Obscure

*Clear glazing option available on all doors.*

*See page 68 for all choices.*

\* Energy ratings based on low E glass on Obscure/Clear and Satin unit. For decorative unit energy rating please enquire separately. Hardware styles shown are representative only - see page 60 for options.

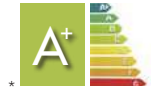

THE **SHERFORD**

SGT1



A SIMPLE, UNDERSTATED LOOK WITH RETRO APPEAL.

Reminiscent of the door styles of the 1930's, The Sherford door is available as a solid door option as well as a glazed.

- 1. The Sherford in Victory Blue with Simplicity glazing style
- 2. The Sherford in Golden Oak



1

2

Dimensions

Width			
Min (Narrow)	Min (Std)	Max (Narrow)	Max (Std)
804mm	840mm	984mm	1020mm
Height			
Min (Narrow)	Min (Std)	Max (Narrow)	Max (Std)
1962mm	1980mm	2070mm	2088mm

## Glazing Options



1



2



3

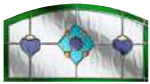

4



5



6



7



8



9

- |                |               |
|----------------|---------------|
| 1. Kensington  | 6. Beaumont   |
| 2. Prairie     | 7. Simplicity |
| 3. Reflections | 8. Satin      |
| 4. Dorchester  | 9. Obscure    |
| 5. New Orleans |               |

*Clear glazing option available on all doors.  
See page 68 for all choices.*

\* Energy ratings based on low E glass on Obscure/Clear and Satin unit. For decorative unit energy rating please enquire separately.  
Hardware styles shown are representative only - see page 60 for options.



THE **DERWENT**

SG14



ELEGANT LINES WITH CHARMING GLAZING PANELS.

The Derwent teams elegant lines with charming glazing panels ideal for allowing light in and providing you the opportunity to personalise your home.

- 1.** The Derwent in Anthracite Grey with Murano glazing style
- 2.** The Derwent in Very Berry with Murano glazing style



1

2

Dimensions

Width			
Min (Narrow)	Min (Std)	Max (Narrow)	Max (Std)
804mm	840mm	984mm	1020mm
Height			
Min (Narrow)	Min (Std)	Max (Narrow)	Max (Std)
1962mm	1980mm	2070mm	2088mm



## Glazing Options



- |                  |                |
|------------------|----------------|
| 1. Kensington    | 8. New Orleans |
| 2. Flair         | 9. Classic     |
| 3. Prairie       | 10. Modena     |
| 4. Elegance      | 11. Simplicity |
| 5. Zinc Art Star | 12. Murano     |
| 6. Reflections   | 13. Satin      |
| 7. Dorchester    | 14. Obscure    |

*Clear glazing option available on all doors.  
See page 68 for all choices.*

\* Energy ratings based on low E glass on Obscure/Clear and Satin unit. For decorative unit energy rating please enquire separately. Hardware styles shown are representative only - see page 60 for options.



THE **AMBER**

SGA3



HALF MOON TOP PANEL MEETS DUAL RECTANGULAR SIDE PANELS.

The striking half-moon window of The Amber makes a great statement of style and beauty for your front door. Available in a Georgian Bar option.

- 1. The Amber in Mulberry with Dorchester Green glazing style
- 2. The Amber in Green



1

2

Dimensions

Width			
Min (Narrow)	Min (Std)	Max (Narrow)	Max (Std)
804mm	840mm	984mm	1020mm
Height			
Min (Narrow)	Min (Std)	Max (Narrow)	Max (Std)
1962mm	1980mm	2070mm	2088mm

## Glazing Options

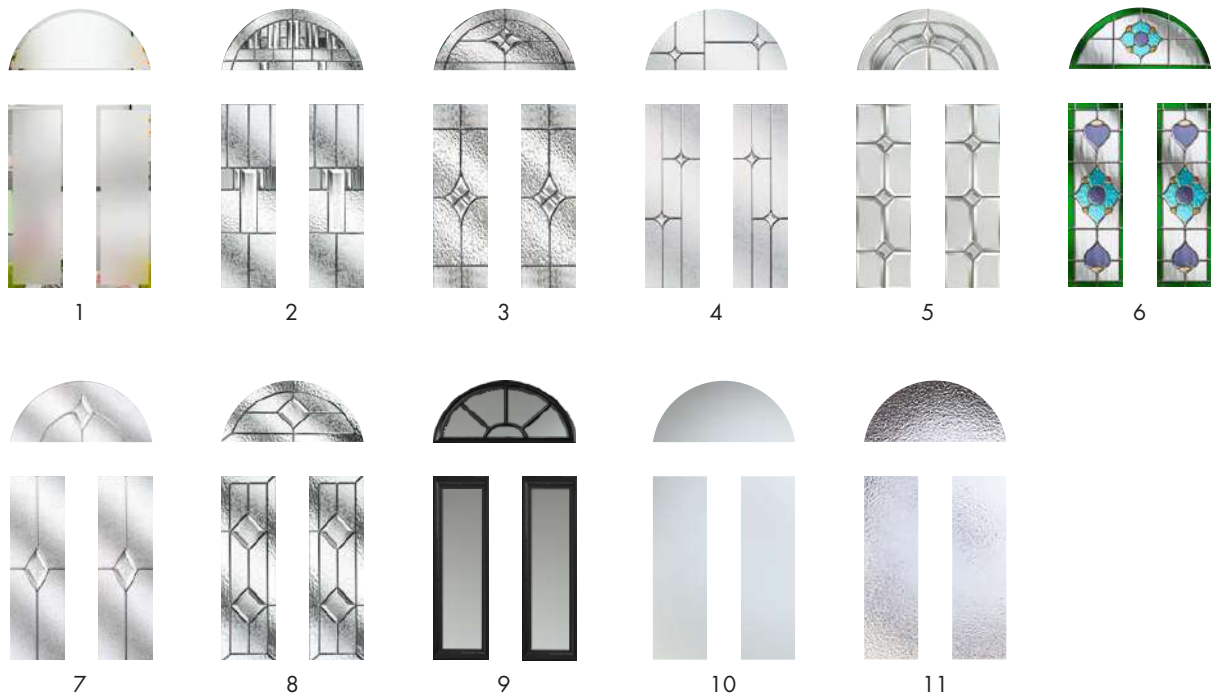

- |                  |                |                   |
|------------------|----------------|-------------------|
| 1. Kensington    | 5. Reflections | 9. Georgian Bar** |
| 2. Prairie       | 6. Dorchester  | 10. Satin         |
| 3. Elegance      | 7. Classic     | 11. Obscure       |
| 4. Zinc Art Star | 8. Simplicity  |                   |

*\*\*Available in door colour with Satin, Obscure or Clear glass. Please note: Our Georgian Bars are a gridded cassette. Bars are surface mounted and not within the glazing unit.*

*Clear glazing option available on all doors.  
See page 68 for all choices.*

\* Energy ratings based on low E glass on Obscure/Clear and Satin unit. For decorative unit energy rating please enquire separately.  
Hardware styles shown are representative only - see page 60 for options.



THE **SANDHILL | DOVE**

SGRV | SG34



A CONTEMPORARY DOOR WITH DOUBLE ARCHED WINDOWS

The graceful double arched windows of The Sandhill make a great statement of style and beauty for your front door. Also available in a more traditional Dove design.

- 1. The Sandhill in Agate Grey with Classic glazing style
- 2. The Dove in Rosewood with Simplicity glazing style



Dimensions

Width			
Min (Narrow)	Min (Std)	Max (Narrow)	Max (Std)
804mm	840mm	984mm	1020mm
Height			
Min (Narrow)	Min (Std)	Max (Narrow)	Max (Std)
1962mm	1980mm	2070mm	2088mm

## Glazing Options

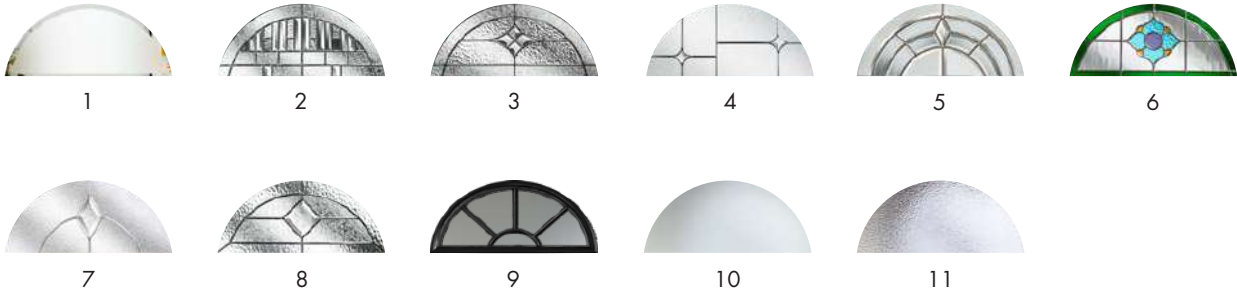

- 1. Kensington
- 2. Prairie
- 3. Elegance
- 4. Zinc Art Star
- 5. Reflections
- 6. Dorchester

- 7. Classic
- 8. Simplicity
- 9. Georgian Bar\*\*
- 10. Satin
- 11. Obscure

*\*\*Available in door colour with Satin, Obscure or Clear glass. Please note: Our Georgian Bars are a gridded cassette. Bars are surface mounted and not within the glazing unit.*

*Clear glazing option available on all doors.*

*See page 68 for all choices.*

\* Energy ratings based on low E glass on Obscure/Clear and Satin unit. For decorative unit energy rating please enquire separately. Hardware styles shown are representative only - see page 60 for options.



SG15

THE **ECCLESBOURNE**

SG11



A TRADITIONAL 6 PANEL DOOR WITH TWO HIGH LEVEL LIGHTS.

A classic look for older homes or contemporary houses that can be glazed with a choice of one of our decorative glass options.

- 1. The Ecclesbourne in Chartwell Green with Kensington glazing style
- 2. The Ecclesbourne in Caribbean Blue



1

2

Dimensions

Width			
Min (Narrow)	Min (Std)	Max (Narrow)	Max (Std)
804mm	840mm	984mm	1020mm
Height			
Min (Narrow)	Min (Std)	Max (Narrow)	Max (Std)
1962mm	1980mm	2070mm	2088mm

## Glazing Options



1



2



3



4



5



6



7



8



9



10



11



12



13



14



15

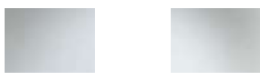

16



17

- |                  |                |
|------------------|----------------|
| 1. Kensington    | 10. Matrix     |
| 2. Flair         | 11. Millennium |
| 3. Linear        | 12. Classic    |
| 4. Prairie       | 13. Modena     |
| 5. Elegance      | 14. Simplicity |
| 6. Zinc Art Star | 15. Murano     |
| 7. Reflections   | 16. Satin      |
| 8. Dorchester    | 17. Obscure    |
| 9. New Orleans   |                |

*Clear glazing option available on all doors.  
See page 68 for all choices.*

\* Energy ratings based on low E glass on Obscure/Clear and Satin unit. For decorative unit energy rating please enquire separately. Hardware styles shown are representative only - see page 60 for options.



THE **LATHKILL**

SG03



OUR POPULAR HALF GLAZED DOOR FOR GREATER LIGHT ENTRY.

Allowing light to flood into the room beyond, The Lathkill door option may also be personalised with a decorative glazing panel of your choice.

- 1. The Lathkill in Citrine with Beaumont glazing style
- 2. The Lathkill in Black



1

2

Dimensions

Width

Min (Narrow)	Min (Std)	Max (Narrow)	Max (Std)
804mm	840mm	984mm	1020mm

Height

Min (Narrow)	Min (Std)	Max (Narrow)	Max (Std)
1962mm	1980mm	2070mm	2088mm



## Glazing Options



1



2



3

- |                |                |
|----------------|----------------|
| 1. Kensington  | 7. New Orleans |
| 2. Linear      | 8. Simplicity  |
| 3. Prairie     | 9. Beaumont    |
| 4. Elegance    | 10. Satin      |
| 5. Reflections | 11. Obscure    |
| 6. Dorchester  |                |

*Clear glazing option available on all doors.*

*See page 68 for all choices.*



4



5

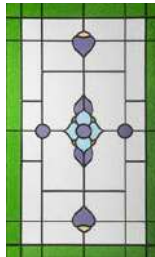

6

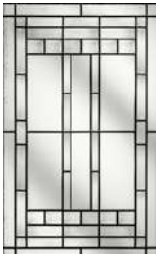

7

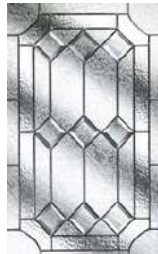

8



9



10



11

\* Energy ratings based on low E glass on Obscure/Clear and Satin unit. For decorative unit energy rating please enquire separately. Hardware styles shown are representative only - see page 60 for options.



THE **EDEN**

SGT2



A TRADITIONAL GRAINED DOOR.

The Eden is available with a complementary glass range designed specifically for this door style

- 1. The Eden in Anthracite Grey with New Orleans glazing style
- 2. The Eden in Black



Dimensions

Width			
Min (Narrow)	Min (Std)	Max (Narrow)	Max (Std)
804mm	840mm	984mm	1020mm
Height			
Min (Narrow)	Min (Std)	Max (Narrow)	Max (Std)
1962mm	1980mm	2070mm	2088mm

## Glazing Options



1



2



3

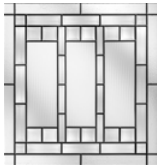

4



5



6

1. Kensington
2. Georgian Bar
3. Dorchester
4. New Orleans
5. Satin
6. Obscure

*Clear glazing option available on all doors.  
See page 68 for all choices.*

\* Energy ratings based on low E glass on Obscure/Clear and Satin unit. For decorative unit energy rating please enquire separately. Hardware styles shown are representative only - see page 60 for options.



THE **BEESTON**

SGA2



A TRADITIONAL GRAINED DOOR WITH ARCHED WINDOW.

The elegant arched window of The Beeston provides beautiful styling with the practical benefits of plentiful daylight. Make the style your own with a choice of decorative glass.

- 1. The Beeston in Red with Elegance glazing style
- 2. The Beeston in Cotswold



Dimensions

Width			
Min (Narrow)	Min (Std)	Max (Narrow)	Max (Std)
804mm	840mm	984mm	1020mm
Height			
Min (Narrow)	Min (Std)	Max (Narrow)	Max (Std)
1962mm	1980mm	2070mm	2088mm

## Glazing Options



1



2



3



4



5



6



7

- 1. Prairie
- 2. Elegance
- 3. Reflections
- 4. Modena
- 5. Simplicity
- 6. Satin
- 7. Obscure

*Clear glazing option available on all doors.*

*See page 68 for all choices.*

\* Energy ratings based on low E glass on Obscure/Clear and Satin unit. For decorative unit energy rating please enquire separately. Hardware styles shown are representative only - see page 60 for options.



# THE **EREWASH**

SG08



## A TRADITIONAL GRAINED 6 PANEL DOOR

The Erewash is a traditional six panelled door suited to most homes. Whether you are choosing a door for a new build or a classic townhouse, The Erewash is an obvious choice.

- 1. The Erewash in Clay
- 2. The Erewash in Very Berry



### Dimensions

#### Width

Min (Narrow)	Min (Std)	Max (Narrow)	Max (Std)
804mm	840mm	984mm	1020mm

#### Height

Min (Narrow)	Min (Std)	Max (Narrow)	Max (Std)
1962mm	1980mm	2070mm	2088mm

\* Energy ratings based on low E glass on Obscure/Clear and Satin unit. For decorative unit energy rating please enquire separately. Hardware styles shown are representative only - see page 60 for options.



THE **OGSTON**

SGRA



1

A TRADITIONAL GRAINED TONGUE AND GROOVE DOOR

The Ogston has a homely 'tongue and groove' finish that makes it ideal for either front or rear door applications. This option comes highly recommended as a non-glazed alternative to the ever popular Speedwell.

- 1. The Ogston in White
- 2. The Ogston in Slate

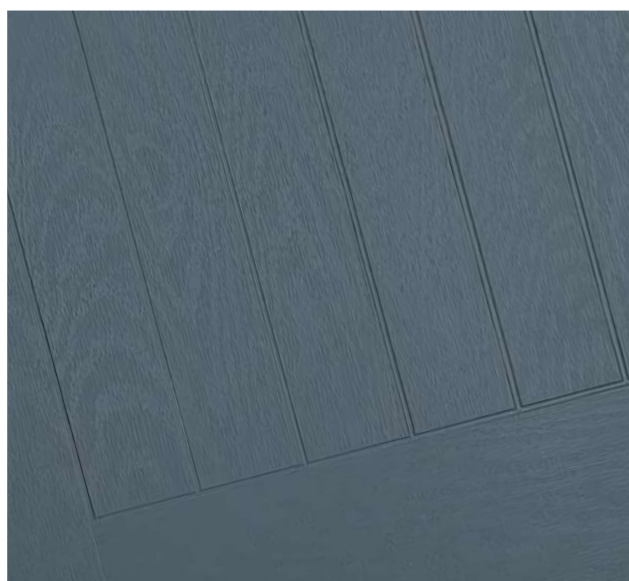

2

Dimensions

Width

Min (Narrow)	Min (Std)	Max (Narrow)	Max (Std)
681mm	717mm	984mm	1020mm

Height

Min (Narrow)	Min (Std)	Max (Narrow)	Max (Std)
1947mm	1966mm	2069mm	2088mm

\* Energy ratings based on low E glass on Obscure/Clear and Satin unit. For decorative unit energy rating please enquire separately. Hardware styles shown are representative only - see page 60 for options.



THE **TRENT**

SGRB



A TRADITIONAL GRAINED DOOR WITH SINGLE APERTURE.

The Trent preserves privacy whilst letting in sunlight with its single aperture. Paired with our sleek contemporary hardware, the Trent is a fantastic addition to any home.

- 1. The Trent in Clay with Aurora glazing style
- 2. The Trent in Chartwell Green



Dimensions

Width			
Min (Narrow)	Min (Std)	Max (Narrow)	Max (Std)
804mm	840mm	984mm	1020mm
Height			
Min (Narrow)	Min (Std)	Max (Narrow)	Max (Std)
1962mm	1980mm	2070mm	2088mm



## Glazing Options



1



2



3



4



5



6



7



8



9

1. Kensington
2. Aurora
3. Finesse
4. New Orleans
5. Millennium
6. Greenwich
7. Richmond
8. Satin
9. Obscure

*Clear glazing option available on all doors.*

*See page 68 for all choices.*

\* Energy ratings based on low E glass on Obscure/Clear and Satin unit. For decorative unit energy rating please enquire separately. Hardware styles shown are representative only - see page 60 for options.

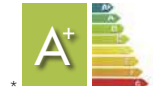

THE **SPEEDWELL**

SGRE



A TRADITIONAL GRAINED DOOR WITH SINGLE APERTURE.

A perfect blend of the Ogston and Farndon door styles, The Speedwell preserves privacy whilst letting some of the outside in with its single aperture. Paired with our sleek contemporary hardware, The Speedwell is a fantastic addition to any home.

- 1. The Speedwell in Victory Blue with Prairie glazing style
- 2. The Speedwell in Slate

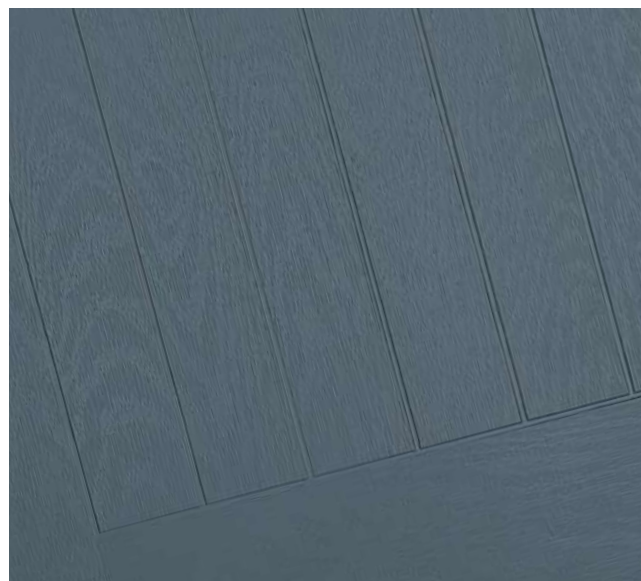

2

Dimensions

Width			
Min (Narrow)	Min (Std)	Max (Narrow)	Max (Std)
804mm	840mm	984mm	1020mm
Height			
Min (Narrow)	Min (Std)	Max (Narrow)	Max (Std)
1962mm	1980mm	2070mm	2088mm

## Glazing Options



1



2



3



4



5



6



7



8



9



10



11



12



13



14

- |                    |                |                |
|--------------------|----------------|----------------|
| 1. Kensington      | 6. Aurora      | 11. Simplicity |
| 2. Flair           | 7. Reflections | 12. Murano     |
| 3. Prairie         | 8. Dorchester  | 13. Satin      |
| 4. Elegance        | 9. New Orleans | 14. Obscure    |
| 5. Crystal Flowers | 10. Classic    |                |

Clear glazing option available on all doors. See page 68 for all choices.

\* Energy ratings based on low E glass on Obscure/Clear and Satin unit. For decorative unit energy rating please enquire separately. Hardware styles shown are representative only - see page 60 for options.



THE **WYE | AVON**

SGRC | SGRY



A COMBINATION OF RUSTIC STYLING AND DIAMOND APERTURES.

The Wye and Avon have a rustic appearance with all the benefits of a modern composite door. The diamond shaped glazed panel can be enhanced with a number of glazing options.

- 1. The Wye in Golden Oak with Kensington glazing style
- 2. The Avon in Sage with New Orleans glazing style



Dimensions

Width			
Min (Narrow)	Min (Std)	Max (Narrow)	Max (Std)
804mm	840mm	984mm	1020mm
Height			
Min (Narrow)	Min (Std)	Max (Narrow)	Max (Std)
1962mm	1980mm	2070mm	2088mm

## Glazing Options

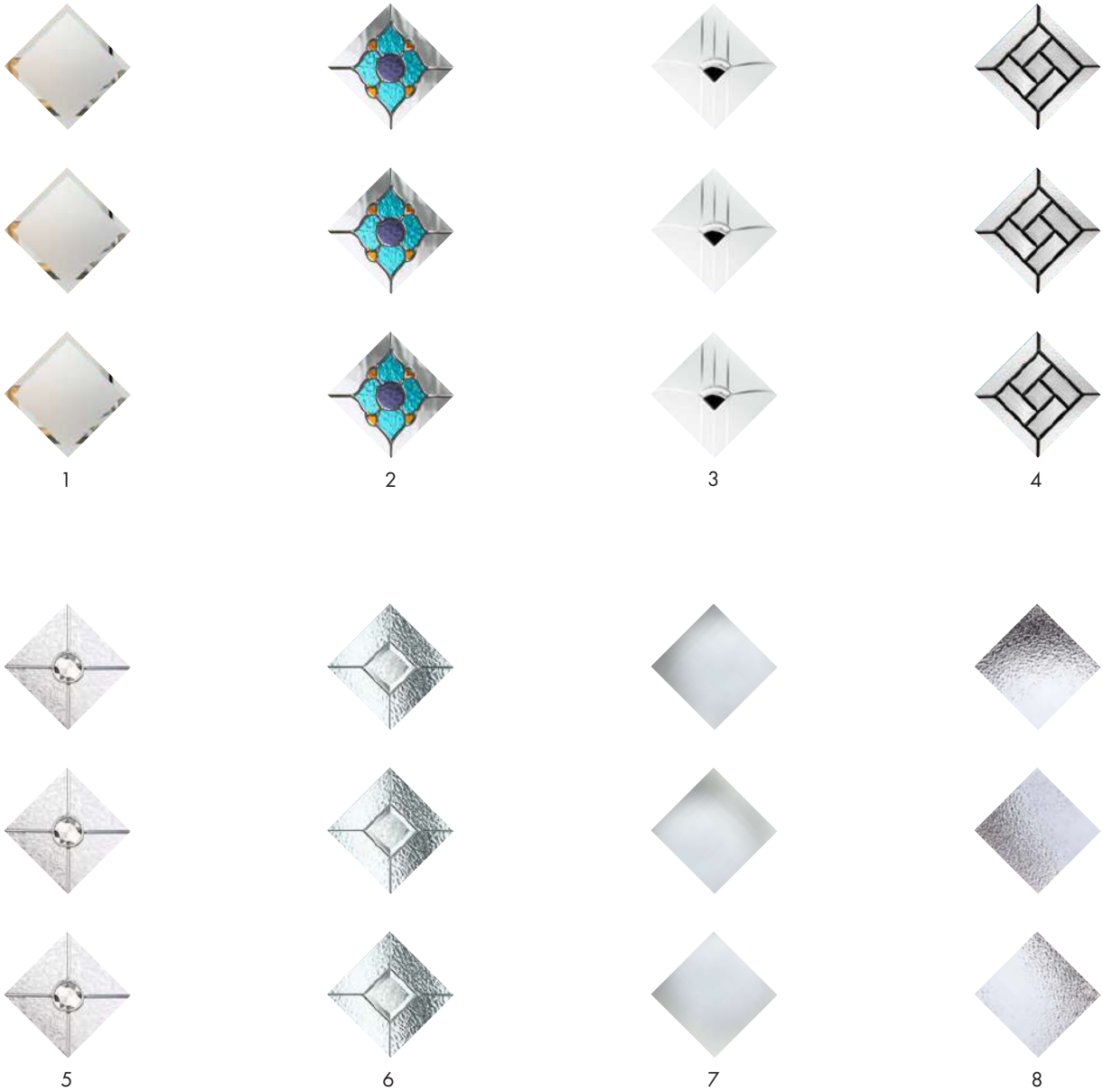

- 1. Kensington
- 2. Dorchester
- 3. Murano

- 4. New Orleans
- 5. Finesse
- 6. Simplicity

- 7. Satin
- 8. Obscure

Clear glazing option available on all doors. See page 68 for all choices.

\* Energy ratings based on low E glass on Obscure/Clear and Satin unit. For decorative unit energy rating please enquire separately. Hardware styles shown are representative only - see page 60 for options.



27  
Syward Row

---

# OUR CONTEMPORARY DOORS

With a stylish, modern design, our contemporary doors are complemented with a wide selection of glass options and configurations.



# THE SHARDLOW | TYNE

Please see style codes in the table below.



## A MODERN DESIGN WITH AN ELEGANT SINGLE GLASS PANEL.

Choose from our wide range of decorative glazing options to add an additional personal touch.

- 1.** The Shardlow in Slate shown middle glazed with Murano glazing style
- 2.** The Tyne in Mulberry shown lock side glazed with Aurora glazing style
- 3.** The Tyne in Golden Oak shown hinge side glazed with New Orleans glazing style



### Glass Position Options

The Shardlow		
Hinge Side	Middle	Lock Side
SGRU	SGRT	SGRS

The Tyne		
Hinge Side	Middle	Lock Side
SGT3	SGT4	SGT5

### Dimensions

Width			
Min (Narrow)	Min (Std)	Max (Narrow)	Max (Std)
804mm	840mm	984mm	1020mm

Height			
Min (Narrow)	Min (Std)	Max (Narrow)	Max (Std)
1962mm	1980mm	2070mm	2088mm



## Glazing Options



1



2



3



4



5



6



7



8



9



10



11



12



13

1. Kensington
2. Linear
3. Prairie
4. Aurora
5. Reflections
6. Richmond
7. Horizon
8. New Orleans
9. Matrix
10. Greenwich
11. Murano
12. Satin
13. Obscure

*Clear glazing option available on all doors.*

*See page 68 for all choices.*

\* Energy ratings based on low E glass on Obscure/Clear and Satin unit. For decorative unit energy rating please enquire separately.  
Hardware styles shown are representative only - see page 60 for options. Glazing layout subject to change based on size requested and hardware choice.



# THE MILTON | FARNDON

Please see style codes in the table below.



## A POPULAR CONTEMPORARY DOOR STYLE FEATURING AN ALTERNATIVE GLAZING CONFIGURATION.

The glazing configuration and positioning can be situated to the left, right or centre to accommodate both the need for privacy and allow daylight into your home.

- 1.** The Milton in Golden Oak shown middle glazed with Classic glazing style
- 2.** The Farndon in Chartwell Green shown hinge side glazed with Prairie glazing style
- 3.** The Milton in Mulberry shown lock side glazed with New Orleans Glazing Style



### Glass Position Options

The Milton		
Hinge Side	Middle	Lock Side
SGRL	SGRK	SGRU

The Farndon		
Hinge Side	Middle	Lock Side
SGRH	SGRG	SGRF

### Dimensions

Width			
Min (Narrow)	Min (Std)	Max (Narrow)	Max (Std)
804mm	840mm	984mm	1020mm

Height			
Min (Narrow)	Min (Std)	Max (Narrow)	Max (Std)
1962mm	1980mm	2070mm	2088mm

## Glazing Options

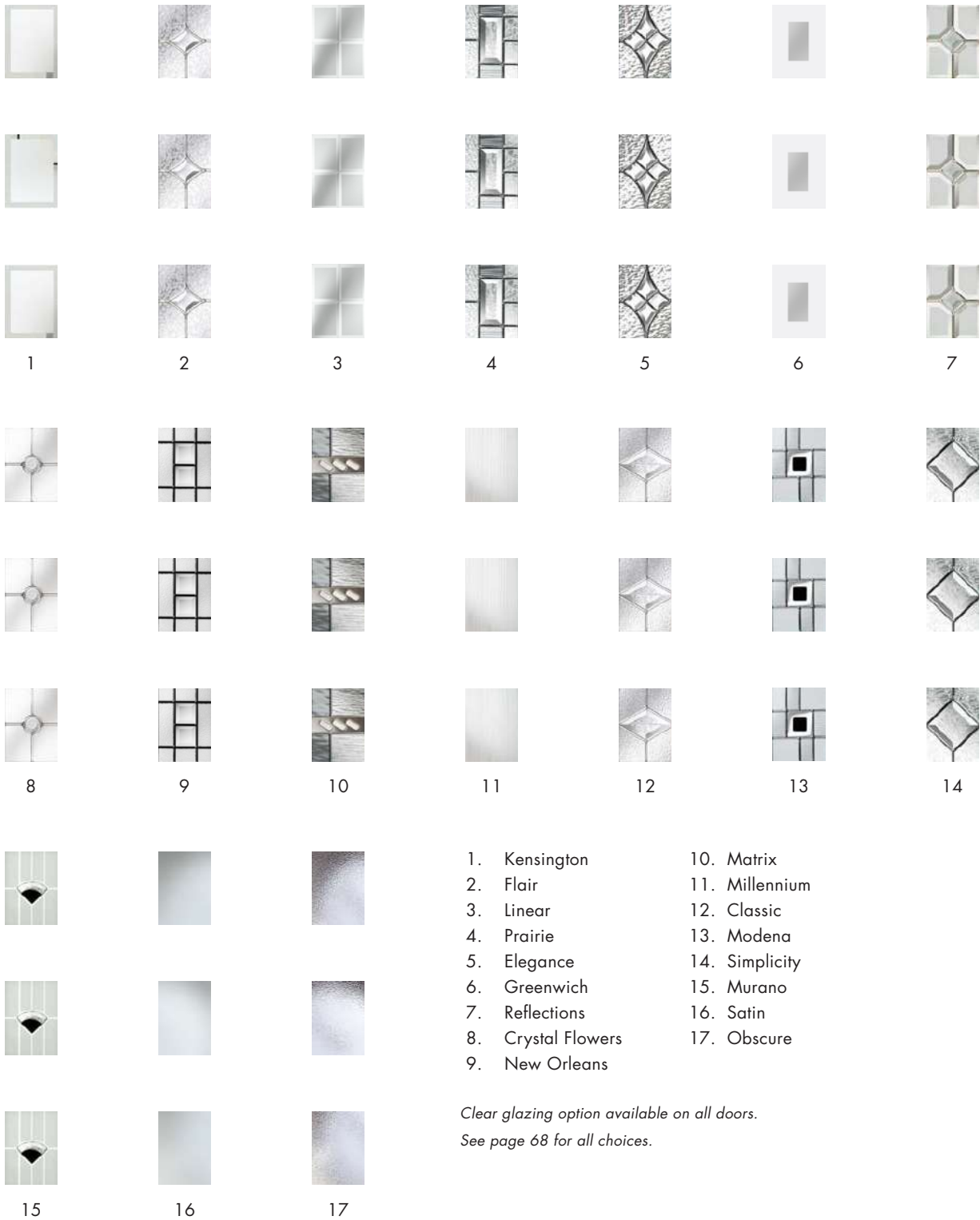

*Clear glazing option available on all doors.  
See page 68 for all choices.*

\* Energy ratings based on low E glass on Obscure/Clear and Satin unit. For decorative unit energy rating please enquire separately.  
Hardware styles shown are representative only - see page 60 for options. Glazing layout subject to change based on size requested and hardware choice.



THE **HILTON**

SGRR



A STRIKING DOOR WITH A GRAINED FINISH & THREE PIECE GLASS DESIGN.

The design of The Hilton is a modern yet desirable composition. One long cassette and two smaller ones at the top and bottom add a great deal of punctuation to this door.

- 1. The Hilton in Marsala with Flair glazing style
- 2. The Hilton in Shadow



Dimensions

Width			
Min (Narrow)	Min (Std)	Max (Narrow)	Max (Std)
804mm	840mm	984mm	1020mm
Height			
Min (Narrow)	Min (Std)	Max (Narrow)	Max (Std)
1962mm	1980mm	2070mm	2088mm

# Glazing Options

1. Kensington

2. Flair

3. Linear

4. Prairie

5. Elegance

6. Zinc Art Star

7. Reflections

8. Dorchester

9. New Orleans

10. Matrix

11. Classic

12. Satin

13. Obscure

10. Matrix

11. Classic

12. Satin

13. Obscure

Clear glazing option available on all doors.  
See page 68 for all choices.

\* Energy ratings based on low E glass on Obscure/Clear and Satin unit. For decorative unit energy rating please enquire separately.  
Hardware styles shown are representative only - see page 60 for options.

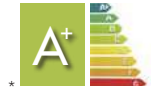

# THE **LOXLEY** | **CALDER**

Please see style codes in the table below.



## A CONTEMPORARY DOOR WITH A SIMPLE GLAZED PANEL

Choose from our wide range of decorative glazing options to add an additional personal touch.

1. The Loxley in Shadow shown hinge side glazed with Matrix glazing style
2. The Loxley in Victory Blue shown lock side glazed with Reflections glazing style
3. The Calder in Bolero shown middle glazed with Horizon glazing style



### Glass Position Options

The Loxley		
Hinge Side	Middle	Lock Side
SGT6	SGT7	SGT8

The Calder		
Hinge Side	Middle	Lock Side
SGT9	SGTA	SGTB

### Dimensions

Width			
Min (Narrow)	Min (Std)	Max (Narrow)	Max (Std)
804mm	840mm	984mm	1020mm

Height			
Min (Narrow)	Min (Std)	Max (Narrow)	Max (Std)
1962mm	1980mm	2070mm	2088mm

## Glazing Options

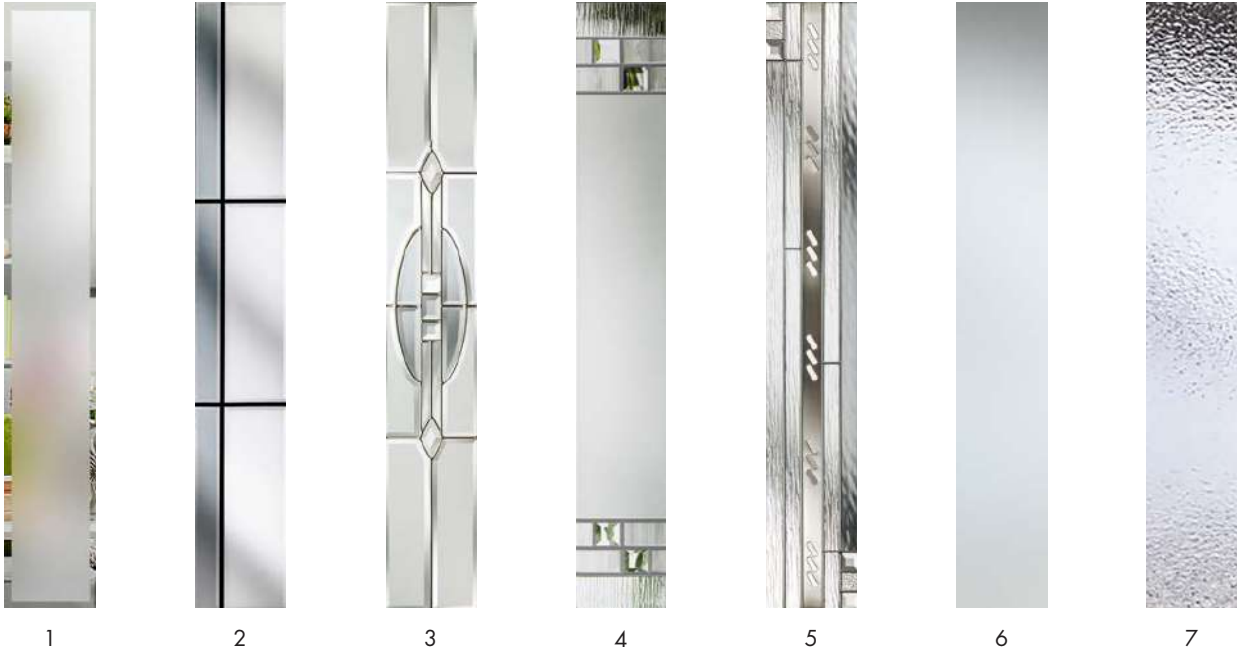

- |                |            |
|----------------|------------|
| 1. Kensington  | 5. Matrix  |
| 2. Aurora      | 6. Satin   |
| 3. Reflections | 7. Obscure |
| 4. Horizon     |            |

*Clear glazing option available on all doors.*

*See page 68 for all choices.*

\* Energy ratings based on low E glass on Obscure/Clear and Satin unit. For decorative unit energy rating please enquire separately.  
Hardware styles shown are representative only - see page 60 for options. Glazing layout subject to change based on size requested and hardware choice.



THE **SHEAF | ARUN | NEATH**

Please see style codes in the table below.



A CONTEMPORARY DOOR WITH LINEAR ETCHED DETAILING

A stunning design using colour-matched cassettes for all colour options.

- 1.** The Sheaf in Clotted Cream shown hinge side glazed with Kensington glazing style
- 2.** The Arun in Mushroom shown lock side glazed with Aurora glazing style
- 3.** The Neath in Agate Grey



Glass Position Options

The Sheaf		
Hinge Side	Middle	Lock Side
SGTC	SGTD	SGTE

The Arun		
Hinge Side	Middle	Lock Side
SGTF	SGTG	SGTH

Dimensions

Width			
Min (Narrow)	Min (Std)	Max (Narrow)	Max (Std)
804mm	840mm	984mm	1020mm

Height			
Min (Narrow)	Min (Std)	Max (Narrow)	Max (Std)
1962mm	1980mm	2070mm	2088mm



## Glazing Options



- |               |                |              |             |            |
|---------------|----------------|--------------|-------------|------------|
| 1. Kensington | 3. New Orleans | 5. Finesse   | 7. Richmond | 9. Obscure |
| 2. Aurora     | 4. Millennium  | 6. Greenwich | 8. Satin    |            |

Clear glazing option available on all doors. See page 68 for all choices.

\* Energy ratings based on low E glass on Obscure/Clear and Satin unit. For decorative unit energy rating please enquire separately.  
Hardware styles shown are representative only - see page 60 for options. Glazing layout subject to change based on size requested and hardware choice.



## THE **REPTON**

Please see style codes in the table below.



### A CONTEMPORARY DOOR WITH SPLIT GLAZED PANEL

The split glazed panel of The Repton, which may be situated to the left, right or centre, allows for a wide choice of both plain or decorative glass designs to provide a contemporary look to the entrance of your home.

1. The Repton in Clotted Cream shown middle glazed with Zinc Art Star glazing style
2. The Repton in Golden Oak

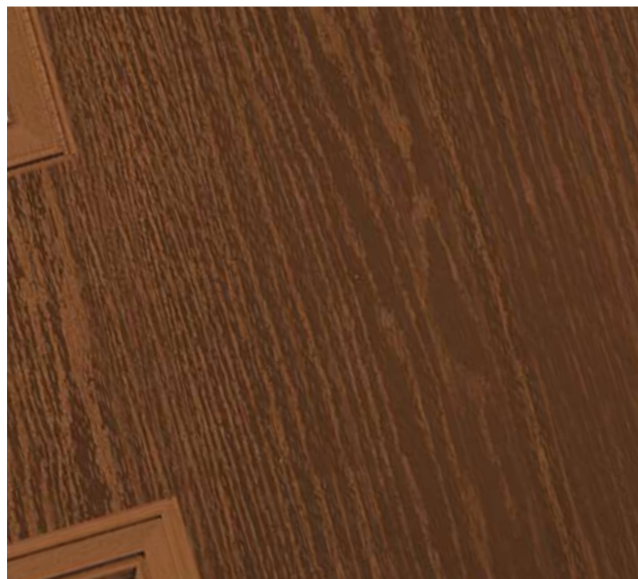

#### Glass Position Options

The Repton		
Hinge Side	Middle	Lock Side
SGRP	SGRN	SGRM

#### Dimensions

Width			
Min (Narrow)	Min (Std)	Max (Narrow)	Max (Std)
804mm	840mm	984mm	1020mm
Height			
Min (Narrow)	Min (Std)	Max (Narrow)	Max (Std)
1962mm	1980mm	2070mm	2088mm

## Glazing Options

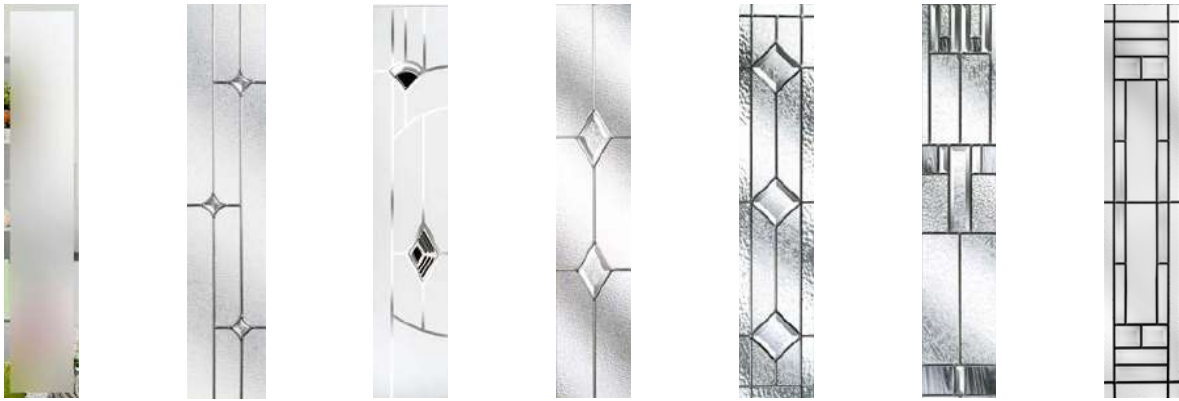

1                      2                      3                      4                      5                      6                      7

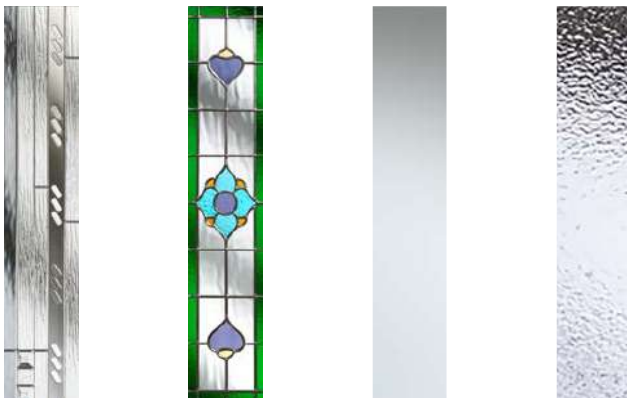

- |                  |                |
|------------------|----------------|
| 1. Kensington    | 7. New Orleans |
| 2. Zinc Art Star | 8. Matrix      |
| 3. Murano        | 9. Dorchester  |
| 4. Classic       | 10. Satin      |
| 5. Simplicity    | 11. Obscure    |
| 6. Prairie       |                |

*Clear glazing option available on all doors.  
See page 68 for all choices.*



8                      9                      10                      11

\* Energy ratings based on low E glass on Obscure/Clear and Satin unit. For decorative unit energy rating please enquire separately.  
Hardware styles shown are representative only - see page 60 for options. Glazing layout subject to change based on size requested and hardware choice.



THE **THAMES** | **COLWYN** | **OGMORE**

SGTJ | SGTK | SGTL



A CONTEMPORARY DOOR STYLE  
FEATURING FOUR INDIVIDUAL  
GLASS PANELS.

A stunning new design using colour matched cassettes for all colour options.

- 1. The Thames in Silver Grey with Greenwich glazing style
- 2. The Colwyn in Diablo with Kensington glazing style
- 3. The Ogmore in Black with Montreal glazing style



Dimensions

Width			
Min (Narrow)	Min (Std)	Max (Narrow)	Max (Std)
804mm	840mm	984mm	1020mm
Height			
Min (Narrow)	Min (Std)	Max (Narrow)	Max (Std)
1962mm	1980mm	2070mm	2088mm

## Glazing Options



1



2



3



4



5



4

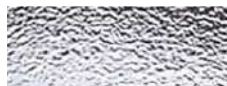

5

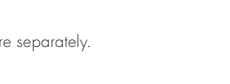
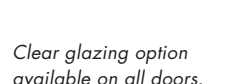
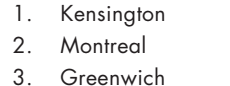

1. Kensington
2. Montreal
3. Greenwich
4. Satin
5. Obscure

*Clear glazing option available on all doors. See page 68 for all choices.*

\* Energy ratings based on low E glass on Obscure/Clear and Satin unit. For decorative unit energy rating please enquire separately. Hardware styles shown are representative only - see page 60 for options.





A range of doors  
synonymous with quality  
and craftsmanship.

**Featured Door:** Loxley in Irish Oak with Millennium glass style. (See page 46 for more detail)

## THE BENCHMARK GUARANTEE







### 1. GRP Composite Door

The rigid construction and high density thermal core make the Benchmark an incredibly reliable and long lasting door. With a 10 year guarantee, you can rest easy with a Benchmark door.



### 2. Surface Finish

With a 10 year surface guarantee, our hard wearing, low maintenance woodgrain GRP skin, provides you with confidence that your door will look this stunning for years to come.



### 3. PVC-U Door Frame

Our reinforced PVC-U frame requires little maintenance and provides a rigid frame for your Benchmark door. Whether you choose white or a woodgrain foil our frames are guaranteed for 10 years.



### 4. Glazing

Our double glazed units are known for their beauty, quality and longevity. A 10 year guarantee on all our glazing units means excellent thermal performance and good looks for the future.



### 5. Hardware

Not only a matter of personal taste, our hardware range gives you choices in guarantees ranging from 5 years through to 10 years too. (See pages 60-67 for more details)



### 6. Threshold

Whether easy access or weather protection are your deciding factors, both our aluminium and PVC-U thresholds are guaranteed for a reassuring 5 years.

## Our Guarantees

- 10 Year Structural Guarantee
- 10 Year Surface Finish Plated Guarantee
- 10 Year Foils Guarantee
- 10 Year PVC-U Surface Guarantee
- 10 Year Guarantee Against Glass Unit Failure

- 5 Year Mechanical Guarantee
- 10 Year Surface Finish Powder Coated Guarantee
- 10 Year Polished Surface Guarantee
- 5 Year Surface Finish Anodised Guarantee

## TOPLIGHTS, SIDELIGHTS & PANEL OPTIONS

The Benchmark range has eight side panel designs to compliment your chosen door and are available in all 43 door colours.

A full range of frame extenders, sills and threshold options are also available. This versatility enables us to match the individual requirements of each installation, to create beautiful and practical entranceways.

Contact us for more information or a quote.



Style 1

Style 2

Style 3

Style 4

Style 5

Style 6

Style 7

Style 8

## Frame Colours

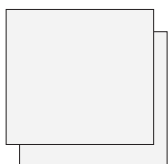

White  
on White



Golden Oak\*  
on White



Rosewood\*  
on White

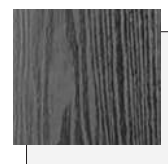

Anthracite\*  
Grey on White



Golden Oak\*  
on Golden Oak\*

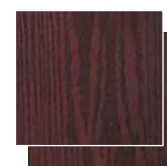

Rosewood\*  
on Rosewood\*



Chartwell Green\*  
on White



Cream\*  
on White\*

\*Grained foils

## PVC-U TOPLIGHT & SIDELIGHT

Our stunning PVC-U sidelight and toplight combinations allow sunlight to flood into your home. Available in 6 frame colours, these options will compliment your Benchmark door perfectly. Please note: all PVC-U sidelights are separate frames.

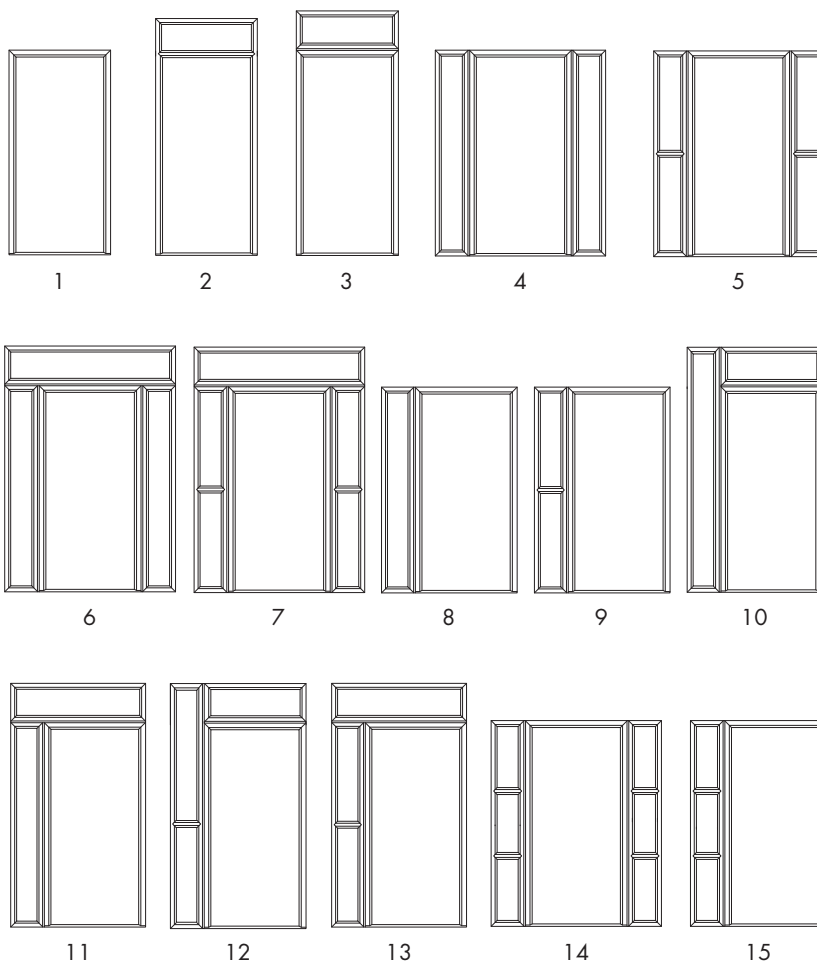

1. Single (Standard)
2. Toplight (Integrated)
3. Toplight (Separate)
4. Double sidelights
5. Double sidelights with midrails
6. Double sidelights with toplight
7. Double sidelights with toplight and midrails
8. Sidelight
9. Sidelight with midrail
10. Extended sidelight with toplight
11. Extended sidelight with toplight and midrail
12. Sidelight with toplight
13. Sidelight with toplight and midrail
14. Double sidelights with two midrails
15. Sidelight with two midrails

### PVC-U Sidelights

Min width: 254mm  
 Max width: 1314mm  
 Max height: 2100mm

*Separate sidelights are measured from edge of frame to edge of transom*

# HARDWARE

## Standard Hardware

Available as standard with all Benchmark doors.

### Performance lever handles ● ● ●



Polished Gold

Polished Chrome

Satin Silver

Black

Lever door handle with an anti-bump cylinder

### Door Hinges ●



Fully adjustable hinge for perfect installations every time (NB Butt hinges used for open out or narrow frames)

### Security door lock ●

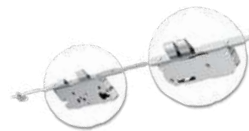

Multi-point locking system using bolts for ultimate security

## Extras ● ● ●

### Performance lever/pad handles



Polished Chrome

Polished Gold

Satin Silver

Black

With external pad handle - split spindle also available

### Pro-style letter box



Polished Gold

Polished Chrome

Satin Silver

Black

Colour matched to suite with range

### Fixed pad handles



Polished Chrome

Polished Gold

Fixed pad door handle with an anti-bump cylinder

- 10 year mechanical guarantee
- 10 year surface finish powder coated guarantee
- 5 year surface finish plated guarantee
- 10 Year Polished Surface Guarantee

*Please note: As part of continued development programme, our standard hardware specification may change without prior notice*

Prolinea door knockers ● ● ●



Victorian Urn  
(Available with spy hole)



Slimline Victorian Urn  
(Available with spy hole)



Pony Tail



Modern Oval

Letters and numerals ●



Hinges ●



Prolinea spy hole ● ●



Security chain ● ●



Thumbturn ●



## Contemporary Hardware Options

(Available on selected doors).

### Door handles - brushed steel ●

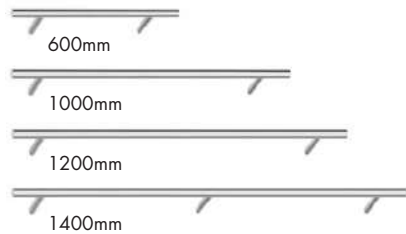

### Letterplate ●



### Lock ●



### Knocker ●



### Escutcheons ●



(Handle option available both sides - escutcheon with pull required if handle fitted externally only)

NB: Contemporary Hardware is not available as part of the Secured By Design upgrade

## Benefit from added security



Secured by Design (SBD) is the official police security initiative that works to improve the security of buildings and their immediate surroundings to provide safe places to live, work, shop and visit.

SBD's product based accreditation scheme – the Police Preferred Specification - provides a recognised standard for all security products that can deter and reduce crime.

To upgrade your door to a Secured By Design door you will need to select the following options:



1



2



3



4



5

- 10 year mechanical guarantee
- 10 Year Polished Surface Guarantee

1. 3 star cylinder
2. Secured by Design letterbox upgrade
3. Security Chain
4. 6.8mm Laminated Glass
5. Spy Hole (Unless clear vision panel selected)

A close-up photograph of a window frame. The frame is made of dark, possibly black, metal or plastic. The glass is a textured, grid-like pattern, likely a safety or privacy glass. The lighting is bright, creating reflections on the glass and the frame. The background is slightly blurred, showing more of the window structure.

A multitude of glass designs to personalise your home.

*Featured Glass Style: Aurora (See page 68 for more detail)*

## HARDWARE UPGRADES

# ULTION

USING UNIQUELY PATENTED SNAP SECURE TECHNOLOGY, ULTION IS ANTI-SNAP, PICK, DRILL AND BUMP RESISTANT, AND IS EASY TO FIT WITH NO ADDITIONAL PREP AND NO NEED FOR CYLINDER GUARDS OR SECURITY HANDLES.

Ultion is 3 star rated straight out of the box, with a lock down mode that activates an attack lock directly into the central cam, keeping an intruder out whilst still being unlockable from the inside - keeping homes and families safe.

Ultion locks are continuously tested; having passed the Sold Secure Diamond Test, it has not yet been beaten. And with the attack lock being housed in Molybdenum, one of the best superalloys in use today, it's little wonder that Ultion has been described as having transformed the door market.



### THE £2,000 ULTION SNAP GUARANTEE

Ultion are offering a FREE 10 year guarantee to homeowners - just register at [www.ultion-lock.co.uk](http://www.ultion-lock.co.uk) within 28 days of installation, and if your home gets burgled as a result of your Ultion lock getting snapped in the following 10 years, you will receive £2,000.



## Unique Features



Over 294,000 combinations produced by 11 pins



Double anti-snap protection, with 6 hardened steel rods and two plates in both ends



3 Star TS007 Test rating, Sold Secure Diamond rating



Thumbturn option available

## Keycap



Very few things go with us everywhere, our keys do. Keycap makes your keys look great and feel much more comfortable whether in your pocket or your hand. A wide variety of colourful caps are available, including glow in the dark options so they are easier to use at night.

Keyring brings all the benefits of Keycap with built in bluetooth. Track or activate the alarm in your keys from your phone and you'll never lose them again! To purchase the key caps please visit the Ultion website.

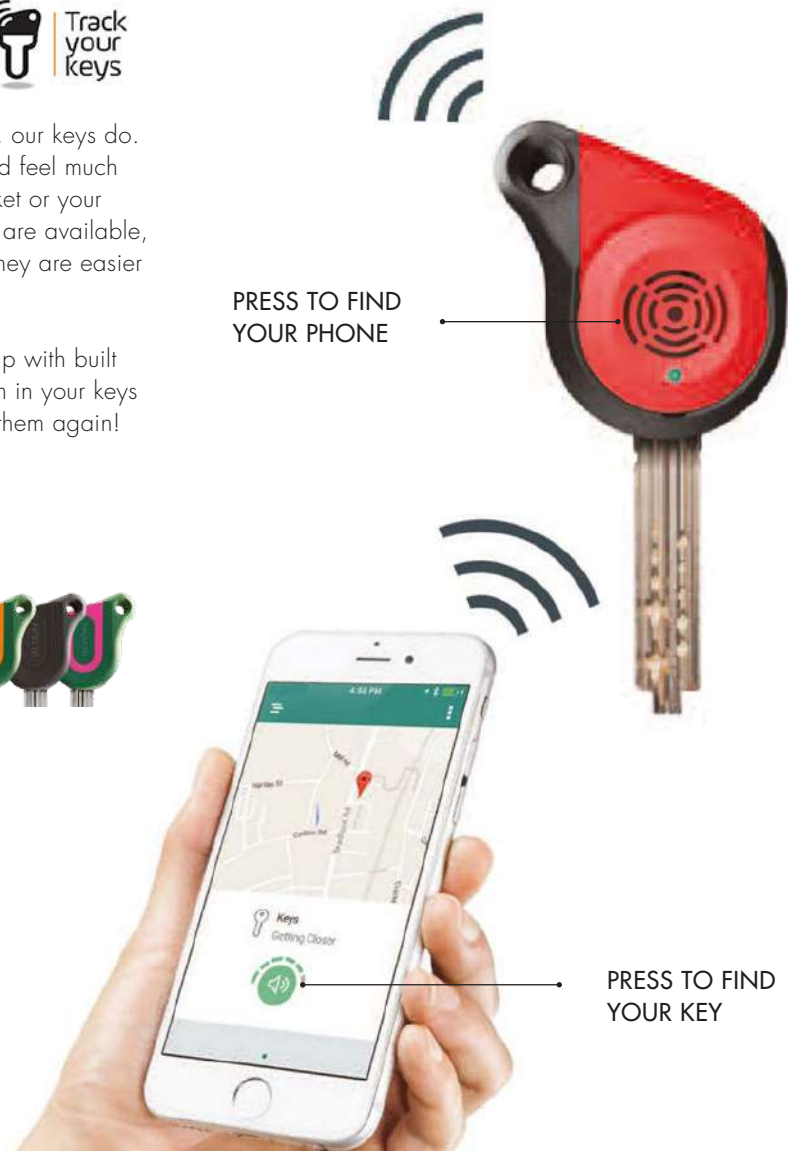

# HARDWARE UPGRADES



WHY SHOULDN'T EXTREME PERSONAL PROTECTION LOOK STUNNING? WITH SWEET'S UNIQUE 'EDGELESS' DESIGN, IT ALWAYS DOES. WHETHER YOUR HOME IS CONTEMPORARY OR TRADITIONAL, COUNTRY-STYLE OR MODERN URBAN, SWEET STAYS EFFORTLESSLY COOL.

Sweet carries multiple coatings of copper and nickel, ensuring it always looks great, even after being hammered with salt water for over 5000 hours. That's an incredible 20x more times than required for

the flagship EN 1906:2012 corrosion standard. With 4 super sleek colours to choose from, there's a sweet for everyone.



## Door Handles

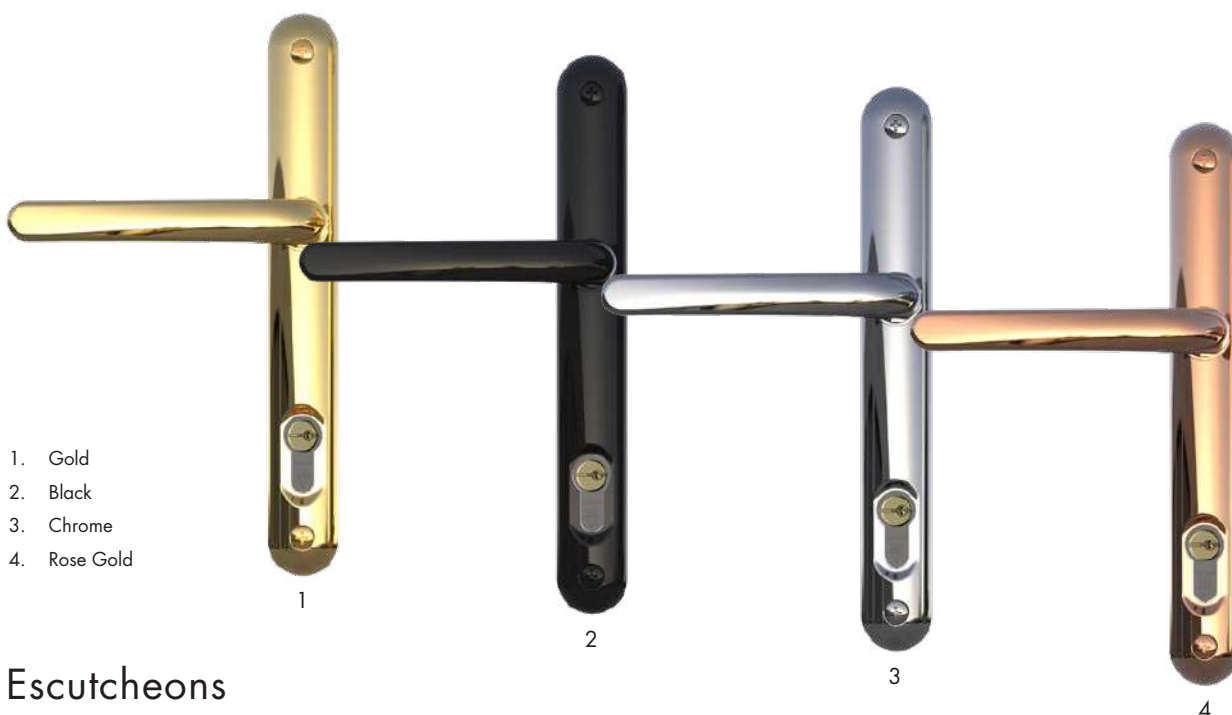

- 1. Gold
- 2. Black
- 3. Chrome
- 4. Rose Gold

1

2

3

4

## Escutcheons



1

2

3

4

- 1. Gold
- 2. Black
- 3. Chrome
- 4. Rose Gold

## Knockers



## Letter Box

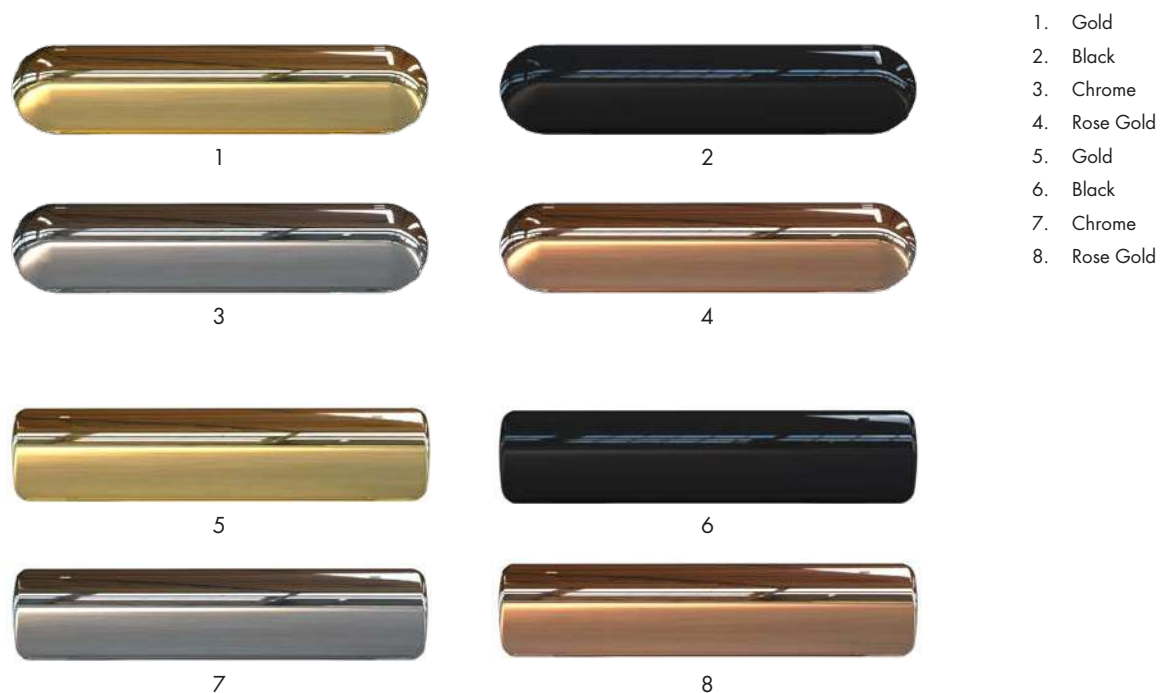

## GLAZING OPTIONS

We have selected the most popular glazing options best suited to our Benchmark door range. From contemporary designs to more traditional glass styles, we know you will find the perfect look for your door. Although not available in every door style, the following images give an indication of colour and appearance.



1



2



3



4



5



6



7



8



9



10



11

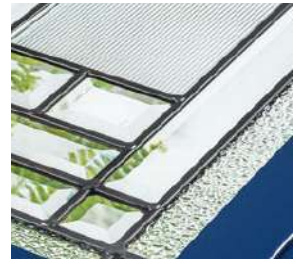

12



13



14



15



16

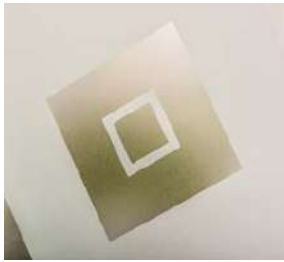

17



18



19



20



21



22



23

- |               |                  |                 |                     |              |
|---------------|------------------|-----------------|---------------------|--------------|
| 1. Kensington | 6. Montreal      | 11. Horizon     | 16. Crystal Flowers | 21. Murano   |
| 2. Flair      | 7. Zinc Art Star | 12. New Orleans | 17. Greenwich       | 22. Finesse  |
| 3. Linear     | 8. Reflections   | 13. Matrix      | 18. Modena          | 23. Richmond |
| 4. Prairie    | 9. Aurora        | 14. Millennium  | 19. Beaumont        |              |
| 5. Elegance   | 10. Dorchester   | 15. Classic     | 20. Simplicity      |              |

## OBSCURE GLASS OPTIONS



Minster



Stippolyte



Cotswold



Satin

### LOW E, ENERGY EFFICIENT GLAZING



Glazing in a GRP composite door will always reduce its thermal efficiency, but by installing our Low E option wherever possible, we can help negate that effect, which is better for the environment and better for your pocket.

 Guarantee against glass unit failure

 Mechanical guarantee

Clear glass also available

## FRAME, SILL AND THRESHOLD OPTIONS

### To complete your door choice

Often it is the finishing touches on a project that make all the difference. To achieve the perfect look for your home, Solar Calibre Doors offer a choice of frame, threshold and sill options.

### Frame Options

With our standard Chamfered frame style, you may select from a range of colours and woodgrains to individualise your door.



#### Multi-chamber profile

With 8 chambers, our multi-chambered frames give an impressive thermal performance as standard

#### Environmentally friendly frames

Lead-free profile and plastic thermal reinforcements (PTRs) are both thermally efficient and incredibly strong with the added bonus of being light and quick to install

#### Triple sealed

Our innovative system uses three gaskets to reduce heat loss and improve weather-tightness

#### Secure construction

With 72% better screw retention than through steel, PTRs offer more secure fixing of hardware keeping your frame rigid, stable and secure

1. PTR Reinforcement
2. Multiple chambers
3. Triple seals (Gasket & woolpile seals)
4. Lead-free PVC-U

### Door Sizing Options

Our door sizes are dependant on the style you choose but most follow the sizing options below. A wide range of frame extenders and panels may be added for non-standard apertures.

Width				Height			
Min (Narrow)	Min (Std)	Max (Narrow)	Max (Std)	Min (Narrow)	Min (Std)	Max (Narrow)	Max (Std)
804mm	840mm	984mm	1020mm	1962mm	1980mm	2070mm	2088mm

NB The above heights do not include a sill, please add 35mm to each if a sill is required

## PVC-U Sill

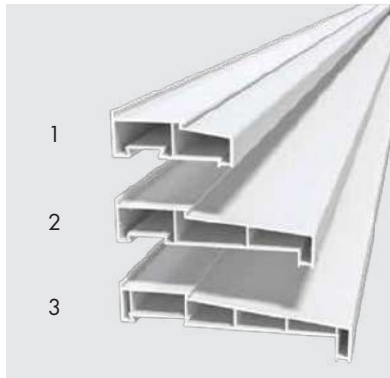

1. 90mm stub sill
2. 150mm sill
3. 180mm sill

PVC-U sills will match your PVC-U door frame as standard.

## Thresholds

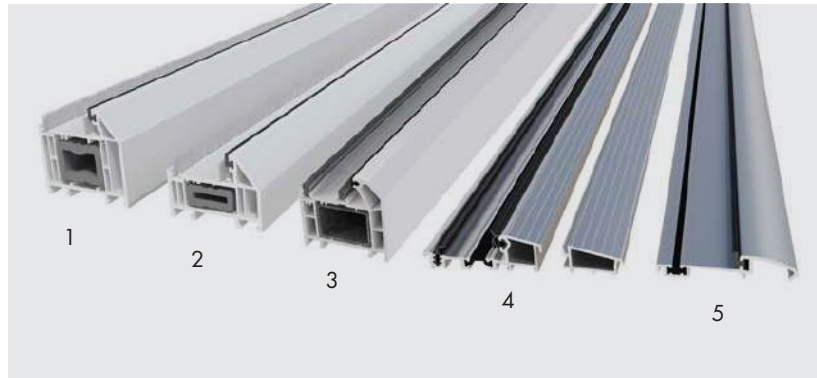

1. PVC-U threshold (Standard)
2. PVC-U threshold (Low)
3. Frame option for steel reinforcement
4. Aluminium threshold (Standard, with option of ramp)
5. Low aluminium threshold (Part M compliant)

You have a choice of thresholds from Solar Calibre. The standard offering is an aluminium threshold with a height of 25mm.

The low aluminium threshold is just 15mm high and creates a low step when your door is open. The low threshold is suitable for disabled and wheelchair access and is Part M compliant.

The standard PVC-U threshold provides a four sided door frame. When your door is open you will have a deeper frame to step over. However, the PVC-U option provides the tightest and most thermally efficient weather seal as the door sits behind the frame on all four sides.

## Frame Colours

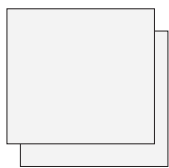

White  
on White



Golden Oak\*  
on White

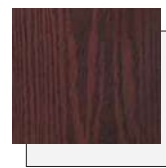

Rosewood\*  
on White

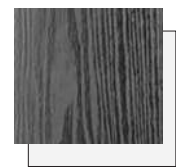

Anthracite\*  
Grey on White



Golden Oak\*  
on Golden Oak\*



Rosewood\*  
on Rosewood\*



Chartwell Green\*  
on White



Cream\*  
on White\*

\*Grained foils

## CUSTOMER SUPPORT

AT SOLAR CALIBRE DOORS, OUR EXPERIENCED AND SKILLED CUSTOMER CARE TEAM IS ALWAYS ON HAND TO PROVIDE TECHNICAL ADVICE, ANSWER ANY DOOR STYLE ENQUIRIES, PROVIDE INSTALLATION ADVICE AND TO ASSIST WITH PROJECT ENQUIRIES.

We ensure that our customers have all the information they require to make the best choice and to provide excellent service.

### How to use this brochure

---

In designing this brochure, we aim to provide you with all the information you need in order to choose the perfect door solution. At your finger tips, you have detailed product information, photographs, hardware choices, quality guarantees and glazing options.

### How to purchase a Benchmark Door

---

The Benchmark Door is widely available via our network of installers across the country. Please call or email us and we will be able to put you in touch with your nearest stockist.

Phone : 01623 275030  
Email : [sales@solarcalibre.co.uk](mailto:sales@solarcalibre.co.uk)

### For Trade customers only

---

To place your order with us, you can do it in one of three ways:

Phone : 01623 275030  
Email : [sales@solarcalibre.co.uk](mailto:sales@solarcalibre.co.uk)  
Online : [doors.solarcalibre.co.uk](http://doors.solarcalibre.co.uk)

Be sure to have your account number handy when making your order, so we can find your business details quickly on our system.



### We have the technical know-how

---

Unsure what door or hardware would be best for a specific job? Our team has specialist working knowledge of our product range, give them a call for helpful technical advice and support.

### You can trust us to deliver

---

We measure our success in accurately providing what you ordered, quickly and on time. Our composite door range is now bigger and better than ever before and we keep our stock holding high so you don't have to. Remember: keep us informed if you are planning a large project and we will make sure we have everything you need in stock.



## DISCOVER MORE FROM SOLAR CALIBRE DOORS



### CRAFTSMAN

We create doors.

The Solar Calibre Craftsman range of doors combines precision engineering, quality construction and stunning good looks.

With 30 door styles to choose from and with 24 beautiful lifestyle colours available, Solar Calibre Craftsman is a truly outstanding door.

For more on Craftsman, visit:  
[solarcalibrenorvik.com/craftsman](http://solarcalibrenorvik.com/craftsman)



### WARDEN

Fire doors without compromise.

The Warden range was developed with a focus on ensuring exemplary performance and constantly exceeding the standards expected.

Fully furnace tested on both sides, as well as smoke tested to European standards, each door type has been stringently tested to ensure consistency of performance.

For more on Warden, visit:  
[solarcalibrenorvik.com/warden](http://solarcalibrenorvik.com/warden)



### PORTIUM

Thermal efficiency at its core.

Portium timber front doors are designed with both beauty and function in mind.

With a range of contemporary and traditional finishes in a wide range of colours, Portium ensures you can bring your vision to life without compromising on quality.

For more on Portium, call us on:  
**01623 275030**





# BENCHMARK

A style to suit every home.

#SetTheBenchmark



### **Solar Calibre Doors Ltd,**

Common Road,  
Huthwaite,  
Nottinghamshire  
NG17 6AD

**Email:** [info@solarcalibre.co.uk](mailto:info@solarcalibre.co.uk)

**Phone:** 01623 275030

### **The Solar Group of companies includes:**

Solar Calibre Doors Ltd (12606317)

Solar Windows Ltd (02678809)

Solar Norvik Ltd (12610230)

Fire Doors by Solar Ltd (11670160)

